



SHADE AUSTRALIA SUNHAVEN GRANDE INSTALLATION & OPERATION GUIDE

Umbrella Components

- Umbrella
- Protection Cover
- Stub Mast
- Crank Handle
- Small Alan Key
- Wind Stabiliser Bars (if purchased)
- M12 Bolts x4 (if using bolt-down base) OR
- Inground base (if purchased)

Dimensions

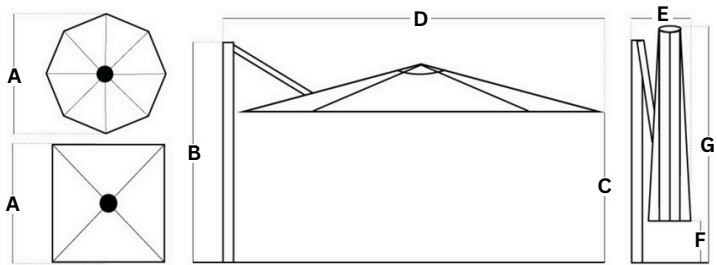

	A	B	C	D	E	F	G
3.5m Square	3500	2816	2200	3789	550	360	2858
4m Octagonal	4000	2800	2205	4000	460	816	2847

*All measurements in mm

Contents

- Page 2** - Base Alignment
- Page 3** - Inground Base Installation
- Page 4** - Bolt-down Base Installation
- Page 5** - Opening Instructions
- Page 6** - Tilting The Umbrella
- Page 6** - Rotating The Umbrella
- Page 7** - Wind Stabiliser Bar Installation
- Page 8** - Closing The Umbrella
- Page 8** - Furling The Fabric

Terminology Key

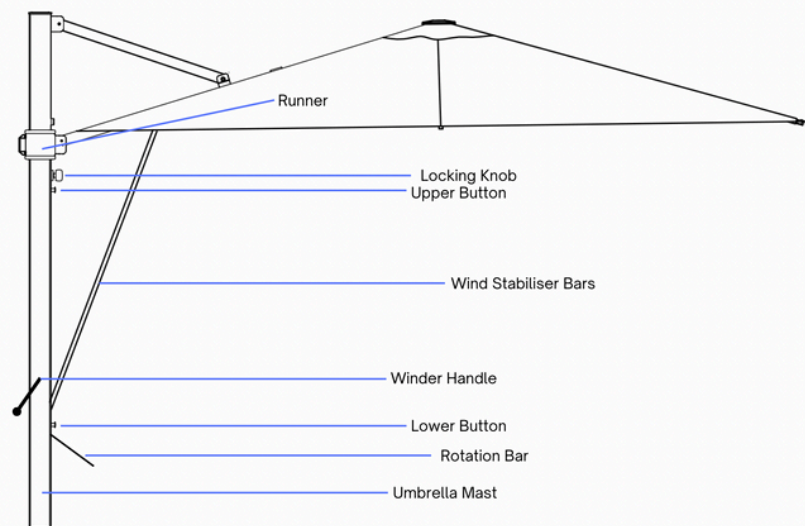

Base Installation

The Sunhaven Grande stub mast (spigot) can be installed onto a reinforced concrete slab or an inground base. The spigot uses locking points around the top perimeter of the mast that the locking pin clips into, which is important as it allows the umbrella to be able to rotate 360° and lock at any desired point.

1 Base Alignment

Correctly aligning the umbrella base with the surrounding walls/edges is an important part of the installation process and must be done before the spigot is set.

For bolt-down bases, the exact spigot alignment must be marked before drilling commences.

For inground bases, the spigot should be attached to the inground base and oriented to the correct position before the base is set into cement. The alignment process goes as follows:

- Insert a dowel such as a drill bit, pencil or metal rod, through opposite holes in the top of the base (1 & 2). This will give a clear visual of the set location the umbrella will face when locked.
- Position the spigot in the set location with the dowel facing the way you intend the umbrella to face (eg. perpendicular to a wall behind it). NB: The screw holes on the bottom will face a different orientation to the dowel - ignore these holes, they aren't a reliable indicator of the umbrellas' orientation (3).
- After this has been determined, the base can be set or drilled into cement.



1 & 2 - A bolt-down base with a dowel (drill bit) for orientation.

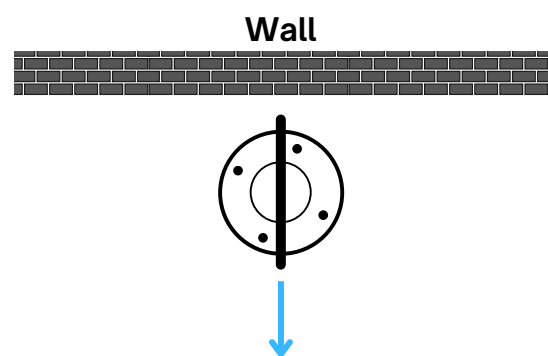

3 - This umbrella will face the way of the blue arrow, contrary to what the spigot's drill holes may suggest



2 Inground Base Installation

- Dig a hole **60 cm deep** at the intended location for the base. The width of the hole will depend on the type of soil that is being dug into, **harder soil or rock should only require a hole 50 cm wide** and 4 bags of concrete mix, however, **softer and sandy soil will require a wider hole** and more concrete
- After the inground base has been bolted to the spigot and aligned to the desired orientation, vertically install the base into wet cement so that the bottom of the in ground flange is flush with the top of the concrete (4).
- Check to make sure that the base is dead level with a spirit level against the pole of the spigot (5).
- Let the concrete harden for approximately 3 hours, then remove the spigot and countersunk screws and store away. This will ensure that the concrete has hardened enough for the screw holes to remain clear and will prevent the umbrella base from being a trip hazard. Let the concrete set - this should take approximately 7 days (6).
- After the cement has been set, re-secure the umbrella spigot to the inground base using the four countersunk screws and tighten. Check the tightness of these screws again 30 days after attaching the spigot. The spigot has now successfully been installed and the Sunhaven Grande umbrella can be attached.

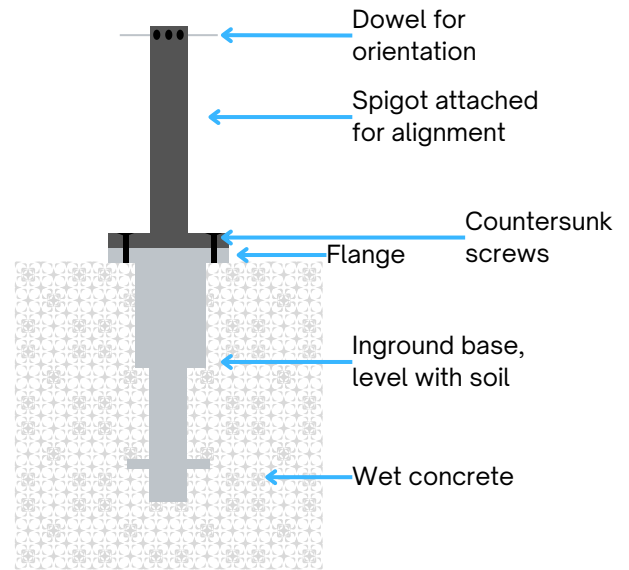

4 (above) - Visual of the in ground base being put into wet cement with the spigot attached for orientation.

5 (right) - Whilst attached to the in ground base, use a spirit level to ensure the spigot is vertical.



6 (left) - leave the base to harden in the cement for approx. 7 days.



3 Bolt-Down Base Installation

- Position the base in the desired spot, ensuring that it has been aligned correctly as per pg.2 instructions. Then mark the four points where the bolts will be going into the ground - this can be done either by briefly drilling into the holes before moving the spigot or marking them with a pen (7).
- Using a drill with a 12mm bit, drill holes in the marked spots 100mm deep for the screw anchors (8). Use a vacuum cleaner or blower to remove dust from the cement that has been drilled into (9).
- Next, place the bolt-down plate over these holes and insert the masonry bolts into the drilled holes, using a soft mallet to tap the bolts in. Tighten the bolts firmly to lock the base to the ground. Check the tightness of these bolts again approximately 1 month after they have been secured to ensure tightness. The umbrella is now ready to be installed and used over the fixed spigot.

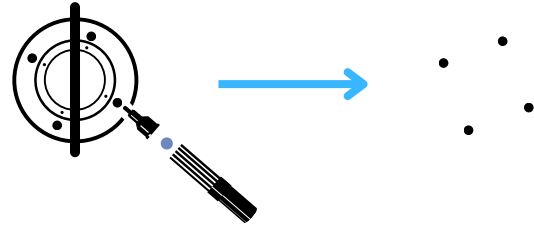

7 (above) - Marking the four drill points whilst the spigot is in place will make it considerably easier to know the exact points to drill into when the spigot is removed.

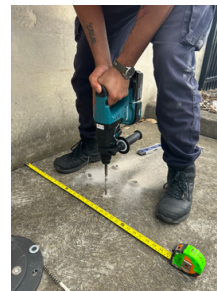

8.



9.



Umbrella Operation

The Sunhaven Grande can be somewhat difficult to open at first due to its size and components. It is recommended that only a person who knows how to open and close this umbrella does so as operating a Sunhaven Grande without the relevant operation knowledge can lead to the umbrella being damaged. This guide will also cover important steps in closing and furling the umbrella too, as this is where damage can be caused to the umbrella.

4 Opening The Umbrella

- Mount the umbrella onto the spigot and take all packaging off. Be careful when doing this and open the umbrella slowly so as to not apply too much pressure onto the arms where packaging may be located.
- Unstrap the umbrella and **push the body of the umbrella forward so it isn't leaning against the mast**, then lift the runner up about 20 cm without winding the umbrella to tension the cord before winding it open. These are important steps as the umbrella will not open comfortably otherwise (10).
- Twist the locking knob anti-clockwise to unlock the umbrella and continuously turn the **winder handle clockwise**. Whilst doing this, simultaneously push the runner up the mast. As a good rule of thumb, keep the vertical level of the runner at the same height as the edge of the fabric as it opens to avoid putting too much strain on the runner's cord. The upper button will click into place at the hole located at the top of the mast, indicating that the umbrella cannot be opened any further.



10 - The procedure before winding the Grande Umbrella.

The umbrella will start closed (top left). Push the frame away from the mast (top right) and the runner vertically until the cord is tight (bottom left) before winding up



5 Tilting The Umbrella

- To tilt the umbrella, pull the upper button (located under the locking knob) back to unlock the umbrella from its standard position.
- From here, the umbrella can be pulled down to any point on the mast. This is done by pulling the handle on the runner either up or down depending on the angle you require (11) Note that the more vertical the umbrella angle is, the more prone it is to wind damage, so be sure to always supervise the Sunhaven Grande while it is in use.
- Once the umbrella is at an optimal angle, retighten the locking. Simply reverse this process to bring the umbrella back to its regular level. The umbrella must be upright before closing.



11 (left) - The Grande tilt in action

6 Rotating The Umbrella

- The umbrella is locked into a set orientation and must be unlocked to rotate. Do this by pulling the lower knob back and twisting it 90° (12). Ensure that the knob clicks back into place at the new orientation.
- The umbrella is now unlocked and can be rotated to any desired angle. To assist with rotating the umbrella, pull the rotation bar out from underneath the lower knob and use it to direct the umbrella in the intended direction (13).



12 (above) - The process of unlocking the rotation button. Notice the 'arms' of the button come out of the groove and rest on the perimeter.



13 (right) - The rotation bar underneath the lower button.



7 Wind Stabiliser Bars

Wind stabiliser bars are specifically made for the Sunhaven Grande. These metal bars lock into the mast and attach to the outer arms. This greatly enhances the stability of the umbrella in breezy conditions. The bars work when the umbrella is in both the tilt and the horizontal positions.

NB: The wind stabiliser bars aren't a guarantee of no wind damage. They are an aid only. Even with stabiliser bars - do not use the umbrella in strong wind conditions.

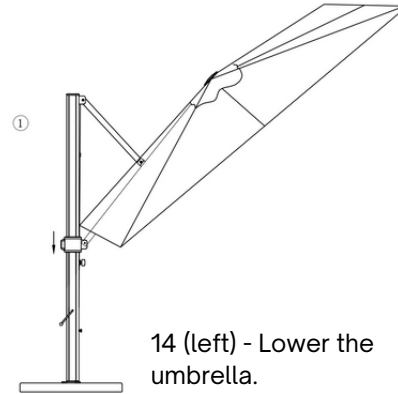

14 (left) - Lower the umbrella.

- Start the bar attachment process by tilting the umbrella to a lower point and locking it in position (14).
- The stabiliser bars attach to the umbrella's back two arm ends. Screw these in using two screw knobs. Do this before attaching the bars to the mast to make the next step easier.
- Fasten the bars to the umbrella mast by screwing them into the movable black threaded block located in the mast. Do this using the remaining screw knob. The block is dynamic in design meaning that the two bars can be stacked on top of each other and screwed into the same hole, and the box can move up or down to any point on the mast to make the screwing process easier.
- The wind stabiliser bars are now attached to the umbrella. The umbrella can be tilted to any point whilst the bars are on the umbrella. They must be unscrewed from the umbrella when it is being closed to avoid frame damage. Repeat this process any time the arms are being connected to the umbrella.



15 (right) - Attach the two bars to the back arm ends using two screw knobs



16 (above) - Connect the two arms together using a screw knob and attach them to the threaded mast block (shown in middle image).

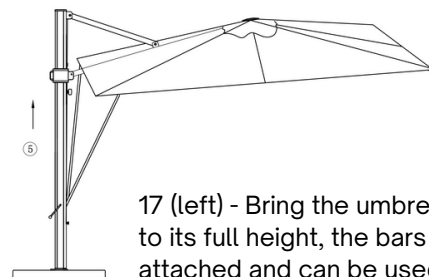

17 (left) - Bring the umbrella back to its full height, the bars are now attached and can be used



8 Closing The Umbrella

- The closing process is similar to the opening process. Assuming that the wind stabilisation arm bars have been unscrewed from the umbrella (if these have been purchased as a component), unlock the umbrella from the top hole by pulling back the upper knob and winding the umbrella anti-clockwise using the winder handle as instructed. Keep the runner at the same level as the fabric edge to make this process as easy as possible.
- Continue winding the umbrella until the frame has collapsed and will not come down any further. **It is extremely important that you stop winding at this point as continuously winding the handle after the umbrella has stopped closing will lead to cable damage.** From here, grasp the umbrella and pull it back toward the mast - the runner will naturally move down into place. At this point the umbrella can be furled.



18 - Bring the umbrella in after it stops closing to avoid putting any strain on the cord. This is done simply by grabbing the umbrella and pulling it in.

9 Furling The Fabric

Due to the size and stiffness of the acrylic fabric, Sunhaven Grande umbrellas need to be furled every time they are closed for an extended period to avoid fabric pinching and to lengthen the lifespan of the canopy.

- Start the furling process by pulling each stretch of fabric out from between each umbrella arm out and away from the umbrella mast.
- Once this has been done, grasp the four left stretches of fabric and furl them toward the 'front' of the umbrella. Repeat this with the four stretches of fabric on the right.
- From here, the attached straps can wrap around the umbrella mast to secure the umbrella closed and the protection cover can be fitted.



19 - Start by pulling all stretches of fabric to the front, then furling the left ones into the middle followed by the right stretches into the middle. Finish by wrapping the attached strap around the umbrella and mast to secure the Grande in place.

